

Data Sheet



Article number: 586351942

Description: Valve 351.942, G 1/2" - G 1/2"
Thread/Thread

Measures

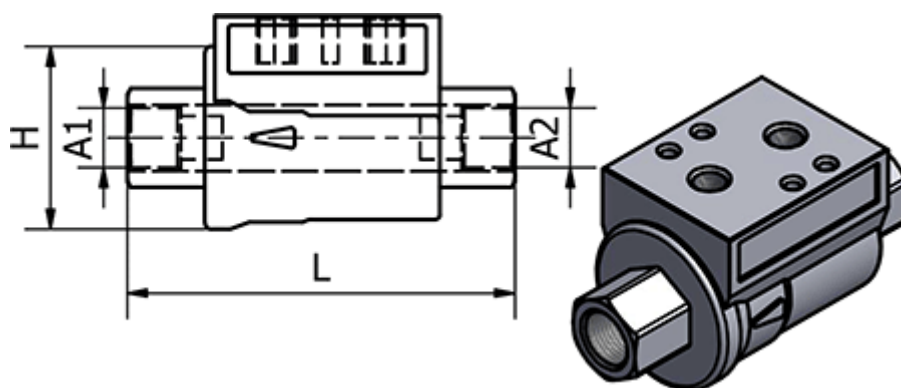

Connecting A1	= G 1/2"
Connecting A2	= G 1/2"
H	= 51.7
L	= 112
Max. Operating Pressure	= 10 bar
Seals	= NBR